

MBC225 Series

Low Profile Open Frame Power Supplies

Medical

Not For New Design
Please refer to exact equivalent product series
MWLP225

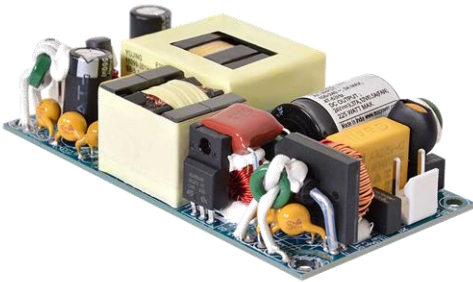

The MBC225 Series of open-frame medical power supplies, with its wide universal 90-264 VAC input range, is available at 225 W of output power and a variety of single and multiple output voltages.

The MBC series is designed and approved to the latest Medical standards (EN/IEC 60601-1), providing 2 x MOPP isolation for Class I & Class II applications.

These power supplies are ideal for medical, telecom, datacom, industrial equipment and other applications.

Key Features & Benefits

- 2 x 4 x 1 Inch Form Factor
- 225 W with Forced Air Cooling
- Approved to EN/IEC 60601-1
- Efficiencies up to 94%
- -40 to 70 °C Operating Temperature
- Dual Fusing
- 12 V Fan Output, Thermal Shut-Down Feature
- 3.37 Million Hours, Telcordia - SR332-Issue 3 MTBF
- Standby Power <0.5 W
- Medical (BF) Safety Approvals
- RoHS Compliant

Applications

- Diagnostic
- Drug Pump
- Monitoring
- Dialysis
- Home Health Care
- Portable Equipment



bel POWER
SOLUTIONS &
PROTECTION

a bel group

belfuse.com/power-solutions

1. MODEL SELECTION

MODEL NUMBER ¹	DESCRIPTION	VOLTAGE	MAX. LOAD			POWER
			CONVECTION 50°C (112.5 W)	CONVECTION 40°C (120 W)	13 CFM (225 W)	
MBC225-1T12L	Screw Terminal	12 V	9.37 A	10.00 A	18.75 A	225 W
MBC225-1012L	Molex Connector					
MBC225-1T15L	Screw Terminal	15 V	7.50 A	8.00 A	15.00 A	225 W
MBC225-1015L	Molex Connector					
MBC225-1T24L	Screw Terminal	24 V	4.68 A	5.00 A	9.37 A	225 W
MBC225-1024L	Molex Connector					
MBC225-1T30L	Screw Terminal	30 V	3.75 A	4.00 A	7.50 A	225 W
MBC225-1030L	Molex Connector					
MBC225-1T48L	Screw Terminal	48 V	2.34 A	2.50 A	4.68 A	225 W
MBC225-1048L	Molex Connector					
MBC225-1T58L	Screw Terminal	58 V	1.94 A	2.07 A	3.88 A	225 W
MBC225-1058L	Molex Connector					
COVER-225-XBC ²	Metal cover kit (accessory)					

¹ Class II version available. Add suffix "-2" at the end of the Model Number

² When used in Cover Kit, de-rate output power to 70 % under all operating conditions.

2. INPUT SPECIFICATIONS

Specifications are for nominal input voltage, 25°C unless otherwise stated.

PARAMETER	DESCRIPTION / CONDITION	SPECIFICATION
Input Voltage	Universal (Derate from 100% at 100 VAC to 90% at 85 VAC)	85 – 264 VAC / 390 VDC
Input Frequency		47 – 63 Hz
Input Current	115 VAC: 230 VAC:	2.2 A max. 1.1 A max.
No Load Power	Typical	< 0.5 W
Inrush Current	115 VAC: 230 VAC: 264 VAC:	25 A 45 A 75 A
Leakage Current	Typical (N.A. For Class II Option) Touch current:	300 µA < 100 µA
Power Factor	With Full Load	> 0.95
Switching Frequency	PFC: PWM:	70 to 130 kHz 50 – 80 kHz

3. OUTPUT SPECIFICATIONS

PARAMETER	DESCRIPTION / CONDITION	SPECIFICATION
Output Voltage	Refer to Model selection table	From 12 V to 58 V
Output Power ³	With 13 CFM Convection:	225 W Up to 120 W
Efficiency	48 V: 24 V, 30 V: 12 V, 15 V:	94% 93% 92%
Hold-up Time	225 W: 110 W:	10 ms 16 ms
Line Regulation ⁵		± 0.5%
Load Regulation ⁵		± 0.5%
Minimum Load		0.0 A
Transient Response	25% step load change, at 0.1A/μs slew rate, 50% duty cycle, 50 Hz = 4%	Recovery time < 5 ms
Ripple ^{4,5}	For all outputs	1.0 % max
Rise Time	Typical	55 ms
Set Point Tolerance ⁵		± 1%
Output Voltage Adjustment ⁶		± 3%
Over Current Protection		>110%
Over Voltage Protection		110 to 140%
Short Circuit Protection	Hiccup mode	
Cooling	With 13 CFM forced air cooling (100 to 264 VAC) ⁷ With natural convection cooling (100 to 264 VAC) ⁸	225 W Up to 120 W

³ Combined output power of main output, fan supply shall not exceed max. power rating.

⁴ Ripple is peak to peak with 20 MHz bandwidth and 10 μF (Electrolytic capacitor) in parallel with a 0.1 μF capacitor at rated line voltage and load ranges.

⁵ Fan supply output voltage tolerance including set point accuracy, line and load regulation is +/- 15 % and ripple and noise is less than 10 %. With V1 fully loaded, Vfan need to have min load of 20 mA to be within regulation band.

⁶ Adjustment potentiometer is located on the SMT side of the PCB

⁷ Refer to Mechanical Drawing

⁸ Refer to Derating Curve

4. EMC SPECIFICATIONS

PARAMETER	DESCRIPTION / CONDITION	SPECIFICATION
Conducted Emissions	EN 55011-B, CISPR22-B, FCC PART15-B	Pass
Radiated Emissions	EN 55011 A; with external core (King core K5B RC 25x12x15-M in input cable)	Pass Level B
Input Current Harmonics	EN 61000-3-2	Class D
Voltage Fluctuation and Flicker	EN 61000-3-3	Pass
ESD Immunity	EN 61000-4-2	Level 4, Criterion A
Radiated Field Immunity	EN 61000-4-3	Level 3, Criterion A
Electrical Fast Transient Immunity	EN 61000-4-4	Level 3, Criterion A
Surge Immunity	EN 61000-4-5	Level 3, Criterion A
Conducted Immunity	EN 61000-4-6	Level 3, Criterion A
Magnetic Field Immunity	EN 61000-4-8	Level 4, Criterion A
Voltage Dips, Interruptions	EN 61000-4-11	Criterion B

5. SAFETY SPECIFICATIONS

PARAMETER	DESCRIPTION / CONDITION	SPECIFICATION
Isolation Voltage	Input to Output: (Medical applications)	4000 VAC
	Input to GND: (Not Applicable For Class II Option)	1500 VAC
	Output to GND: For type BF	1500 VAC
	For type B (Not Applicable For Class II Option)	500 VAC
Safety Standard(s)	EN60601-1, IEC 60601-1 (ed.3), ANSI / AAMI ES 60601 - 1, CSA C22.2 No. 60601-1	
Agency Approvals	Nemko, UL, C-UL	
CE mark	Complies with LVD Directive	

6. ENVIRONMENTAL SPECIFICATIONS

PARAMETER	DESCRIPTION / CONDITION	SPECIFICATION
Operating Temperature	-40 to 0°C startup guaranteed, with spec deviation ⁹	-40 to +70°C
Storage Temperature		-40 to +85°C
Relative Humidity	Noncondensing	5% to 95%
Altitude	Operating:	16,000 ft
	Nonoperating:	40,000 ft.
Reliability	MTBF according to Telcordia -SR332-issue 3:	3.37 million hours

⁹ Output ripple can be more than 10% of the output voltage.

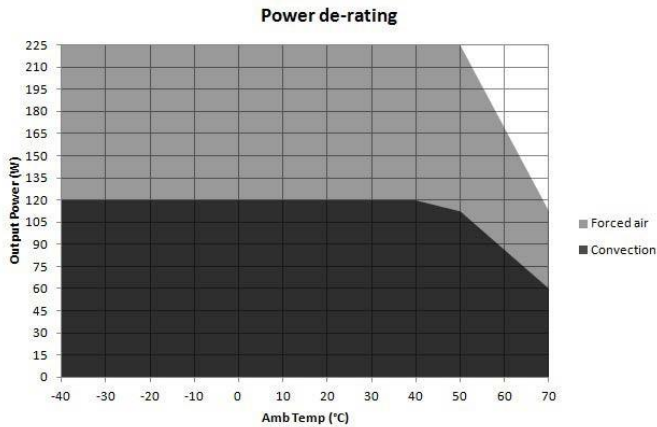

Forced air cooled load: 225 W up to 50°C
De-rate above 50 °C @ 2.5% per °C

Convection load: 120 W up to 40 °C
De-rate between 40-50 °C @ 0.625% per °C
De-rate above 50 °C @ 2.33% per °C

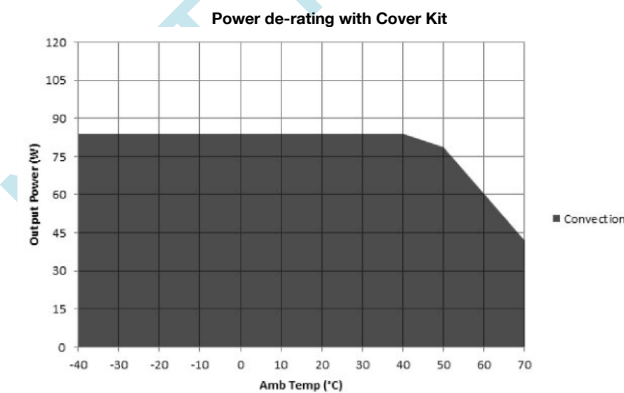

Convection load: 84 W up to 40 °C
De-rate between 40-50 °C @ 0.625% per °C
De-rate above 50 °C @ 2.33% per °C

Figure 1. Derating Curves

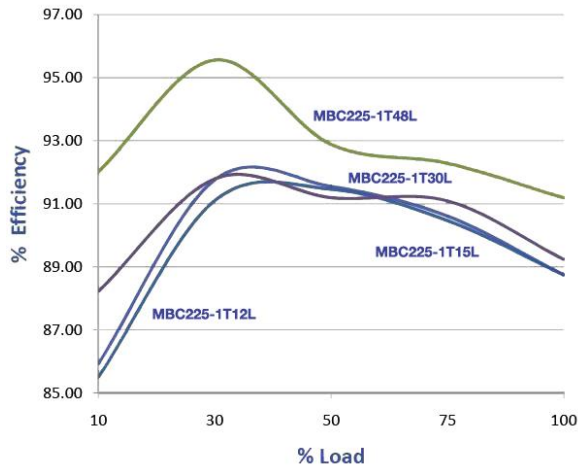

Figure 2. Efficiency Graph at 115 VAC

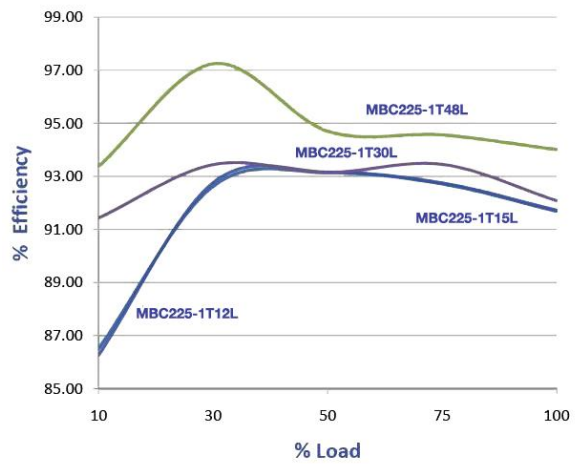

Figure 3. Efficiency Graph at 230 VAC

7. CONNECTOR & PIN DESCRIPTION

CONNECTOR	PIN	DESCRIPTION/CONDITION	MANUFACTURER / PN
AC Input Connector	J1	Pin 1 AC Line Pin 2 Not Fitted Pin 3 AC Neutral	Molex: 26-60-4030 Mating: 09-50-3031; Pins: 08-50-0106
DC Output Connector	J2	Pin 1,2,3 V1 +VE Pin 4,5,6 V1 - VE	Screw Terminal (Option 1)
			Molex Connector (Option 2)
Aux (Fan) Output	J3	Pin 1 FAN +VE Pin 2 FAN - VE	Molex: 39357 Series or equivalent Molex: 26-60-4060 Mating: 09-50-3061; Pins: 08-50-0106 AMP :640456-2 Mating: 640440-2

8. MECHANICAL SPECIFICATIONS

PARAMETER	DESCRIPTION/CONDITION
Weight	200 g approx.
Dimensions	50.8 x 101.6 x 25.4 mm (2 x 4 x 1 inch)

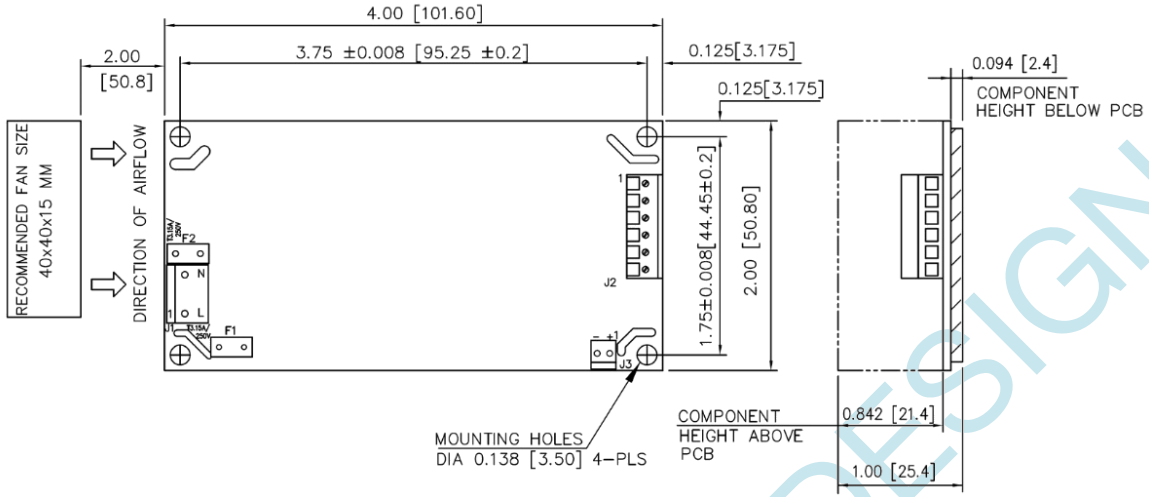

MECHANICAL OUTLINE DIMENSIONS
 ALL DIMENSIONS ARE IN INCHES[MM]
 GEN TOLERANCE : +/-0.04 [+/-1.0MM]

Figure 4. Mechanical Drawing – Screw Terminal (Option 1)

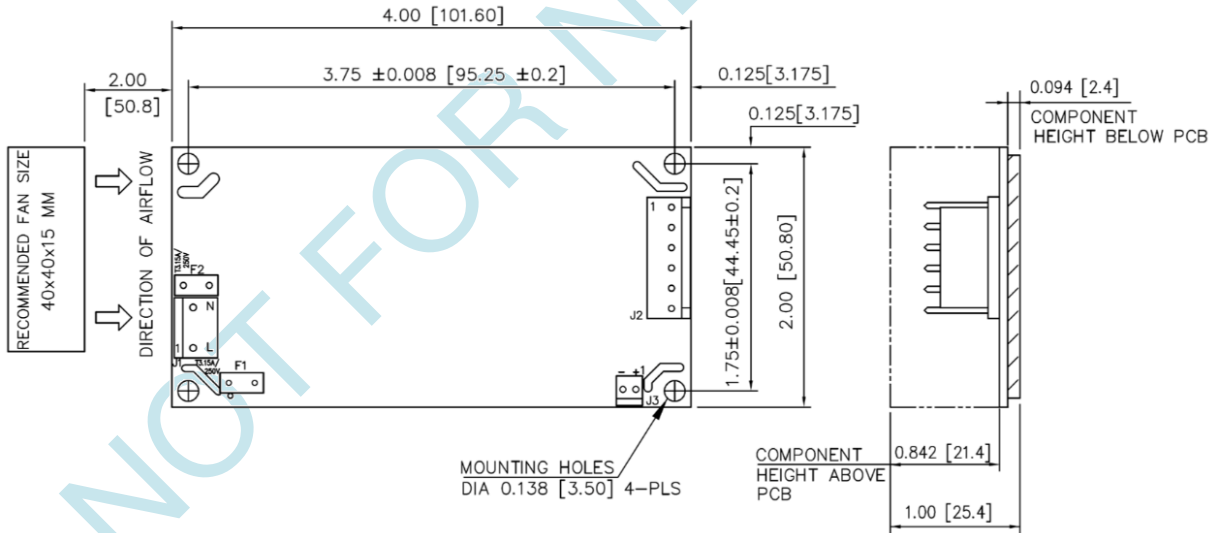

MECHANICAL OUTLINE DIMENSIONS
 ALL DIMENSIONS ARE IN INCHES[MM]
 GEN TOLERANCE : +/-0.04 [+/-1.0MM]

Figure 5. Mechanical Drawing – Molex Connector (Option 2)

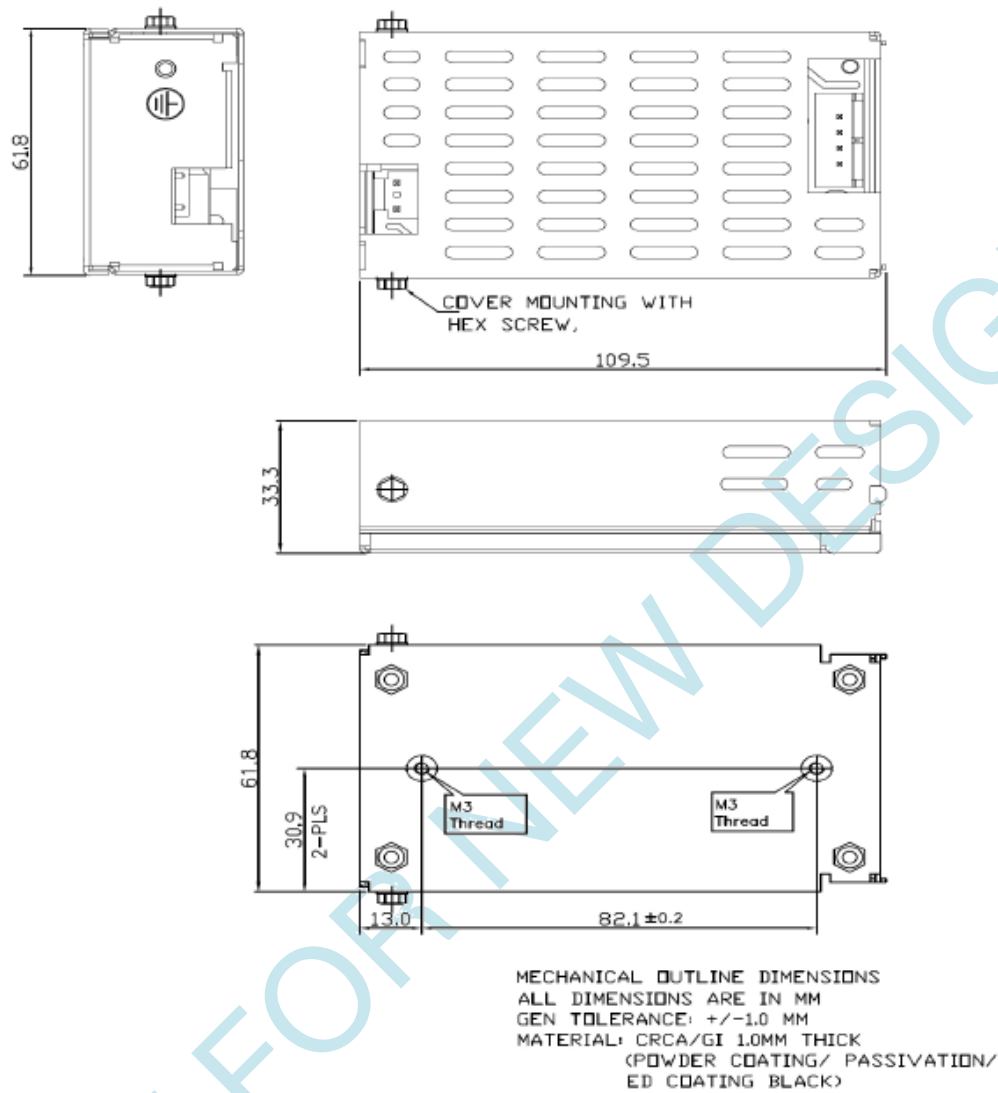

Figure 6. Mechanical Drawing – With Cover Kit

NOTES: In case the PCB is mounted in a metal enclosure, using metal hardware ensure the following:

- 1 Stand off, used to mount PCB has OD of 5.4 mm max.
- 2 Screws, used to fix PCB on stand off, have head dia of 6.0 mm max.
- 3 Washer, if used, to have dia of 6.5 mm max.

For more information on these products consult: tech.support@psbel.com

NUCLEAR AND MEDICAL APPLICATIONS - Products are not designed or intended for use as critical components in life support systems, equipment used in hazardous environments, or nuclear control systems.

TECHNICAL REVISIONS - The appearance of products, including safety agency certifications pictured on labels, may change depending on the date manufactured. Specifications are subject to change without notice.