

TET4800-48-069RA

4800 W AC-DC Front-End Power Supply

Bel Power Solutions **TET4800-48-069RA** is a 4800 Watt AC-DC power-factor-corrected (PFC) and DC-DC power supply that converts standard AC mains power or high voltage DC bus voltages into a main output of 54.5 VDC (42 – 58 VDC) for supplying 48 VDC power distribution in high performance and reliability data centre equipment, servers, routers, and network switches.

The TET4800-48-069RA meets international safety standards and displays the CE-Mark for the European Low Voltage Directive (LVD).

Key Features & Benefits

- Best-in-class efficiency of up to 97%
- Wide input voltage range: Full power at 200-277 VAC or 240-380 VDC
- AC input with power factor correction, usable also with high voltage DC
- 4800 W main output with programmable voltage set point of 42-58 VDC
- Standby output 12 VDC / 48 W
- One single rear side connector for input and output power and signaling
- Parallel operation with active digital current sharing through CAN bus
- Hot-plug capable
- High density design: 53 W/in³
- Small form factor: 69 x 40.6 x 528 mm (2.72 x 1.60 x 20.79 in)
- Full digital controls for improved performance
- CAN communication interface for monitoring, control, and firmware update via bootloader, optional I²C communication instead of CAN bus foreseen
- Overtemperature, output overvoltage and overcurrent protection
- Blackbox recorder available
- 2 Status LEDs: AC OK and DC OK with fault signaling
- Safety-approved to UL/CSA 62368-1 and IEC 62368-1
- RoHS Compliant
- US Patent Pending



Applications

- Data Center
- High Performance Servers
- Routers
- Switches



1. ORDERING INFORMATION

TET	4800	-	48	-	069	R	A	Option Code
Product Family	Power Level	Dash	V1 Output	Dash	Width	Airflow	Input	
TET Front-End	4800 W		48 V		69 mm	R: Reversed ¹	A: AC	Blank: Standard model

2. OVERVIEW

The TET4800-48-069RA is a fully DSP controlled, highly efficient front-end power supply. It incorporates resonant-soft-switching technology and highly integrated conversion stages to reduce component stresses, providing increased system reliability, very high efficiency and high power density. With a wide input operating voltage range and minimal linear derating of output power with respect to ambient temperature, the TET4800-48-069RA maximizes power availability in demanding server, switch, and router applications. The power supply is fan cooled and ideally suited for server integration with a matching airflow path.

The PFC stage is digitally controlled using a state-of-the-art digital signal processing algorithm to guarantee best efficiency and unity power factor over a wide operating range when using AC input voltage. When operated with high voltage DC the PFC circuit is still in operation, but input current is controlled to be DC.

The DC-DC stage uses soft switching resonant techniques in conjunction with synchronous rectification. An active OR-ing device on the output ensures no reverse load current and renders the supply ideally suited for operation in redundant power systems.

The optional always-on +12V standby output provides power to external power distribution and management controllers. Its protection with an active OR-ing device provides for maximum reliability.

Status information is provided with front-panel LEDs. In addition, the power supply can be monitored and controlled (i.e., fan speed setpoint) via CAN communication interface. It allows full monitoring of the supply, including input and output voltage, current, power, and inside temperatures. The same CAN bus supports the bootloader to allow field update of the firmware in the DSP controllers.

Cooling is managed by a fan, controlled by the DSP controller. The fan speed is adjusted automatically depending on the actual power demand and supply temperature and can be overridden through the CAN bus. Availability of an optional I2C bus instead of CAN bus is foreseen.

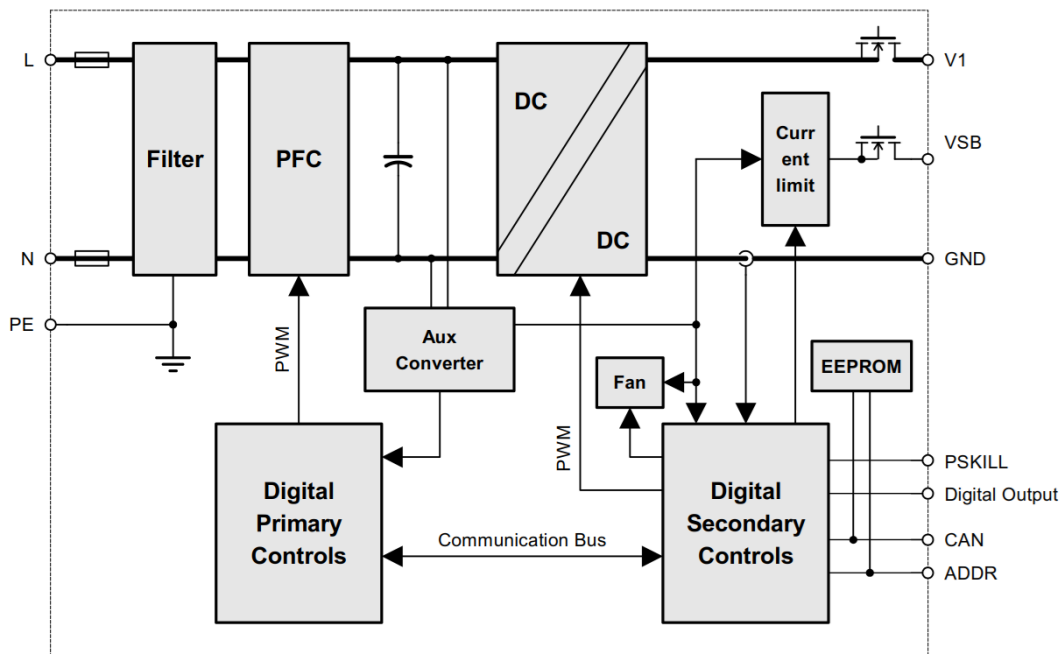

Figure 1. TET4800-48-069RA Block Diagram

¹ Front to Rear

3. ABSOLUTE MAXIMUM RATINGS

Stresses in excess of the absolute maximum ratings may cause performance degradation, adversely affect long-term reliability, and cause permanent damage to the power supply.

PARAMETER	CONDITIONS / DESCRIPTION	MIN	MAX	UNITS
$V_{i\ maxc}$	Maximum Input		305 400	VAC VDC

4. INPUT

General Condition: $T_A = 0...45\ ^\circ\text{C}$ unless otherwise specified.

PARAMETER	DESCRIPTION / CONDITION	MIN	NOM	MAX	UNIT		
$V_{i\ AC\ nom}$	Rated AC Input Voltage	Rated AC Input Voltage	100	230	277	VAC	
$V_{i\ AC\ operating}$	AC Input Voltage Range	Operating AC Input Voltage ($V_{i\ AC\ min}$ to $V_{i\ AC\ max}$)		90	305	VAC	
$V_{i\ AC\ HL}$	High line AC Input Voltage	AC Input Voltage Range with full output power		180	305	VAC	
$V_{i\ AC\ Red}$	Derated AC Input Voltage	AC Input Voltage Range with reduced output power		90	180	VAC	
$V_{i\ DC\ nom}$	Rated DC Input Voltage	Rated DC Input Voltage		240	380	VDC	
$V_{i\ DC\ operating}$	DC Input Voltage range	Operating DC Input Voltage ($V_{i\ DC\ min}$ to $V_{i\ DC\ max}$)		192	400	VDC	
$I_{i\ max}$	Max Input Current	$V_{i\ AC} > 200\ \text{VAC}$ or $V_{i\ DC} > 200\ \text{VDC}$			28	A_{rms}	
$I_{i\ p}$	Inrush Current Limitation	$V_{i\ AC\ min}$ to $V_{i\ AC\ max}$ or $V_{i\ DC\ min}$ to $V_{i\ DC\ max}$			50	A_p	
F_i	Input Frequency	47	50/60	63	Hz		
PF	Power Factor	$V_{i\ AC\ nom}$, 50Hz, $I_1 > 0.3\ I_{1\ nom}$		0.97		W/VA	
THD	Total Harmonic Distortion on Input Current	$V_{i\ AC\ HL}$, $> 50\ \% P_{1\ nom}$		3	5	%	
$V_{i\ AC\ on}$	Turn-on AC Input Voltage ²	Ramping up		86	88	90	VAC
$V_{i\ AC\ off}$	Turn-off AC Input Voltage	Ramping down		80	83	86	VAC
$V_{i\ DC\ on}$	Turn-on DC Input Voltage	Ramping up		183	186	188	VDC
$V_{i\ DC\ off}$	Turn-off DC Input Voltage	Ramping down		176	181	185	VDC
η	Efficiency ³	$V_i = 277\ \text{VAC}$, $0.1 \cdot I_{1\ nom}$, $I_{SB} = 0\ \text{A}$, $V_{x\ nom}$, $T_A = 25\ ^\circ\text{C}$		94.1			
		$V_i = 277\ \text{VAC}$, $0.2 \cdot I_{1\ nom}$, $I_{SB} = 0\ \text{A}$, $V_{x\ nom}$, $T_A = 25\ ^\circ\text{C}$		96.0			
		$V_i = 277\ \text{VAC}$, $0.5 \cdot I_{1\ nom}$, $I_{SB} = 0\ \text{A}$, $V_{x\ nom}$, $T_A = 25\ ^\circ\text{C}$		96.4			
		$V_i = 277\ \text{VAC}$, $I_{1\ nom}$, $I_{SB} = 0\ \text{A}$, $V_{x\ nom}$, $T_A = 25\ ^\circ\text{C}$		95.5			
T_{hold}	Hold-up Time	After last AC zero crossing, $V_i > 41\ \text{V}$, $V_{i\ AC\ nom}$, $P_{1\ nom}$		10		ms	
$T_{hold-up, vsb-to-v01}$	Time from V_{o1} to V_{sb} Leaving Regulation	All hold-up conditions		40		ms	

² The Front-End is provided with a minimum hysteresis of 3 V during turn-on and turn-off within the ranges

³ Efficiency measured with fan loss included in PSU losses. Efficiency excluded fan power loss, refer to section 4.5



4.1. INPUT FUSE

Fast-acting 60 A (parallel $2 \times 30A$) input fuses (7.3 × 33.8 mm) in series the L- line inside the power supply protect against severe defects. The fuses are not accessible from the outside and are therefore not serviceable parts.

4.2. INRUSH CURRENT

The power supply exhibits an X capacitance of 5.8 μF , resulting in a low and short peak current, when the supply is connected to the mains. The internal bulk capacitors will be charged through NTC resistors which will limit the inrush current.

NOTE:

Do not repeat plug-in / out operations below 30 sec interval time, or else the internal in-rush current limiting device (NTC) may not sufficiently cool down and excessive inrush current may result.

4.3. INPUT UNDER-VOLTAGE

If the input voltage is reduced below the input under-voltage lockout threshold $V_{iAC\ off}$ or $V_{iDC\ off}$, the supply will be inhibited. Once the input voltage rises above $V_{iAC\ on}$ or $V_{iDC\ on}$, the supply will return to normal operation again.

4.4. POWER FACTOR CORRECTION

Power factor correction (PFC) is achieved by controlling the input current waveform synchronously with the input voltage. A fully digital controller is implemented giving outstanding PFC results over a wide input voltage and load range. The input current will follow the shape of the input voltage. If, for instance, the input voltage has a trapezoidal waveform, then the current will also show a trapezoidal waveform.

4.5. EFFICIENCY

The high efficiency is achieved by using state-of-the-art silicon power devices in conjunction with soft-transition topologies minimizing switching losses and a full digital control scheme. Synchronous rectifiers on the output reduce the losses in the high current output path. The rpm of the fan is digitally controlled to keep all components at an optimal operating temperature regardless of the ambient temperature and load conditions. *Figure 2* shows the measured efficiency with AC input voltage applied, with standby output at zero load, while *Figure 3* represents the efficiency when operating with high voltage DC input.

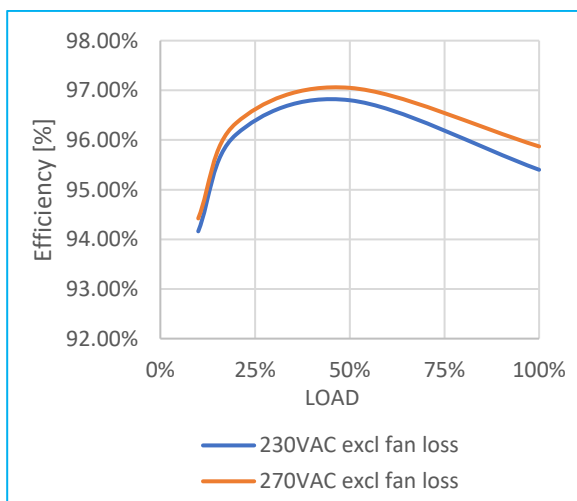

Figure 2. Typical Efficiency vs. Load Current at AC Input

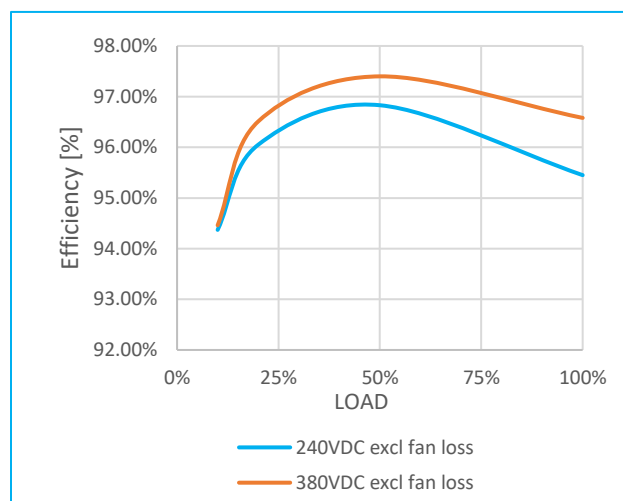

Figure 3. Typical Efficiency vs. Load Current at HVDC Input

TET4800-48-069RA

4800 W AC-DC Front-End Power Supply

5. OUTPUT

General Condition: $T_A = 0 \dots 45^\circ\text{C}$ unless otherwise noted.

PARAMETER	DESCRIPTION / CONDITION	MIN	NOM	MAX	UNIT	
Main Output V₁						
V _{1 nom}	Nominal Output Voltage	0.5 · I _{1 nom} , T _a ≤ 45°C		54.5	VDC	
V _{1 prg}	Programmable Output Voltage Range	0.5 · I _{1 nom} , T _a ≤ 45°C		42	58 VDC	
V _{1 set}	Output Setpoint Accuracy	0.5 · I _{1 nom} , T _a ≤ 45°C		-0.5	+0.5 % V _{1 nom}	
dV _{1 tot}	Total Regulation	V _{i AC min} to V _{i AC max} OR V _{i DC min} to V _{i DC max} , 0 to 100% I _{1 nom} , T _{a min} to T _{a max}		-2	+2 % V _{1 nom}	
P _{1 nom}	Nominal Output Power See Figure 4	V _{i AC HL} OR V _{i DC operating} , T _a ≤ 45°C, V ₁ ≥ 48.0 V		4800	W	
		V _{i AC HL} OR V _{i DC operating} , T _a = 55°C, V ₁ ≥ 48.0 V		4000	W	
I _{1 nom}	Nominal Output Current	V _{i AC HL} OR V _{i DC operating} , T _a ≤ 45°C, V ₁ = 54.5 V		88	ADC	
		V _{i AC HL} OR V _{i DC operating} , T _a = 55 °C, V ₁ = 54.5 V		73	ADC	
		V _{i AC HL} OR V _{i DC operating} , T _a ≤ 45°C, V ₁ = 48.0 V		100	ADC	
		V _{i AC HL} OR V _{i DC operating} , T _a ≤ 45°C, V ₁ = 58.0 V		83	ADC	
P _{1 red}	Available Output Power at V _i < 180 VAC	V _{i AC Red} , T _a ≤ 45°C, V ₁ ≥ 48.0 V		See Figure ⁵	W	
P _{1 red}	Low Line Output Power	V _i = 120 VAC, T _a ≤ 45°C, V ₁ ≥ 48.0 V		2700 ⁴	W	
I _{1 ol}	Short Time Overload Current, Maximum duration 10 ms	V _{i AC Red} , V _{i AC HL} , V _{i DC operating} , relative to static output current available			110	%
V _{1 pp}	Output Ripple Voltage	20 MHz BW T _A = 25 °C		1000	mVpp	
dV _{1 Load}	Load Regulation	V _i = V _{i AC nom} OR V _{i DC nom} , 0 - 100 % I _{1 nom}		-10	mV/A	
dV _{1 Line}	Line Regulation	V _{i AC min} to V _{i AC max} OR V _{i DC min} to V _{i DC max}		0	mV	
dI _{share}	Current Sharing	Deviation from I _{1 tot} / N, I ₁ > 25% I _{1 nom}		-2.5	+2.5 ADC	
dV _{dyn}	Dynamic Load Regulation	ΔI ₁ = 50% I _{1 nom} , I ₁ = 10 ... 100% I _{1 nom} , dI ₁ /dt = 1A/μs, f = 2 ... 50 Hz, Duty cycle = 20 ... 80%		-2	+2 V	
T _{rec}	Recovery Time	Within 1% of V ₁ final steady state I ₁ = 10 ... 100% I _{1 nom}		2	ms	
t _{AC V1}	Start-up Time from AC	Time from V _i in range to V ₁ in regulation, T _A = 25 °C		4 ⁵	sec	
t _{V1 rise}	Rise Time	V ₁ = 10 ... 90% V _{1 nom}		12	ms	
C _{V1}	Maximum Capacitive Load ⁶			15000	μF	

⁴ Example: At nominal grid 120 VAC the max. output power is 2700 W, will be provided also with grid fluctuation -10 % down to 108 VAC.

⁵ At low ambient temperature T_A < 10 °C this time can rise to max 10 s

⁶ PSU tested with E-Load set to constant-resistance mode



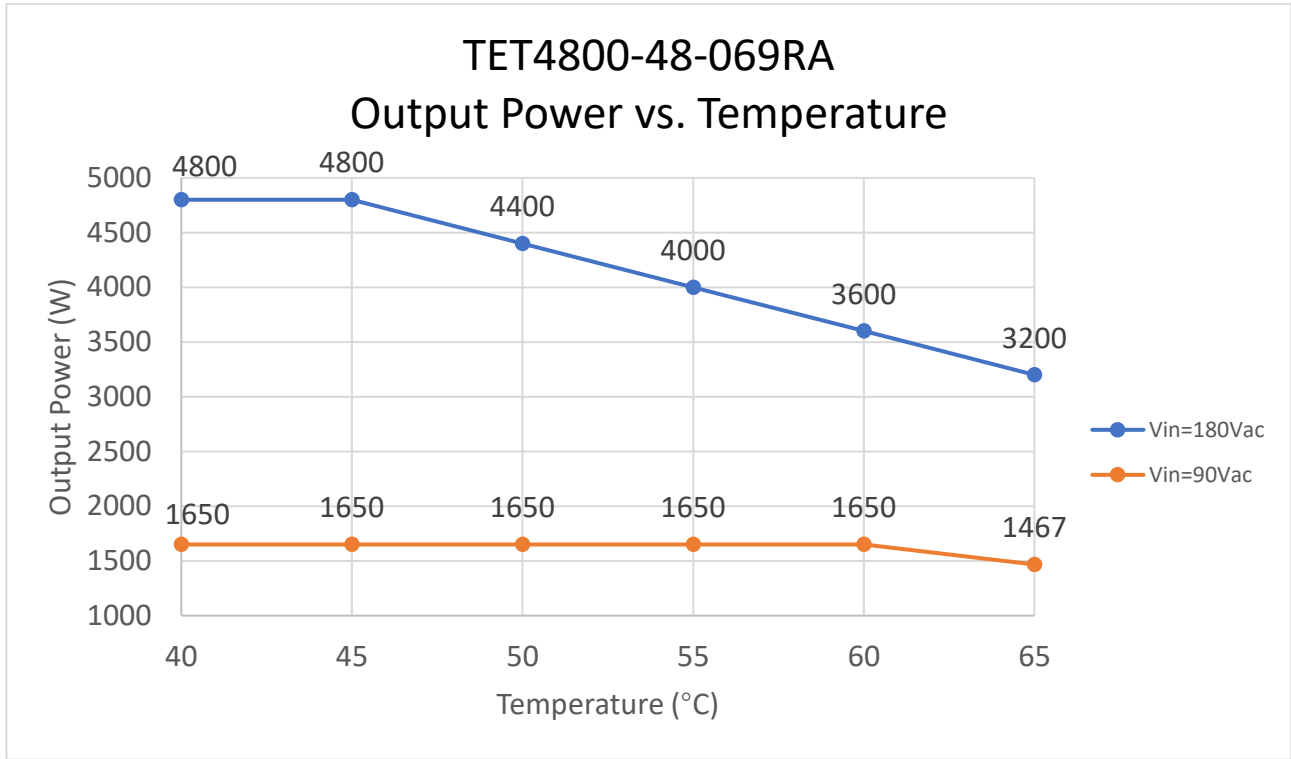

Figure 4. Output Power vs. Temperature

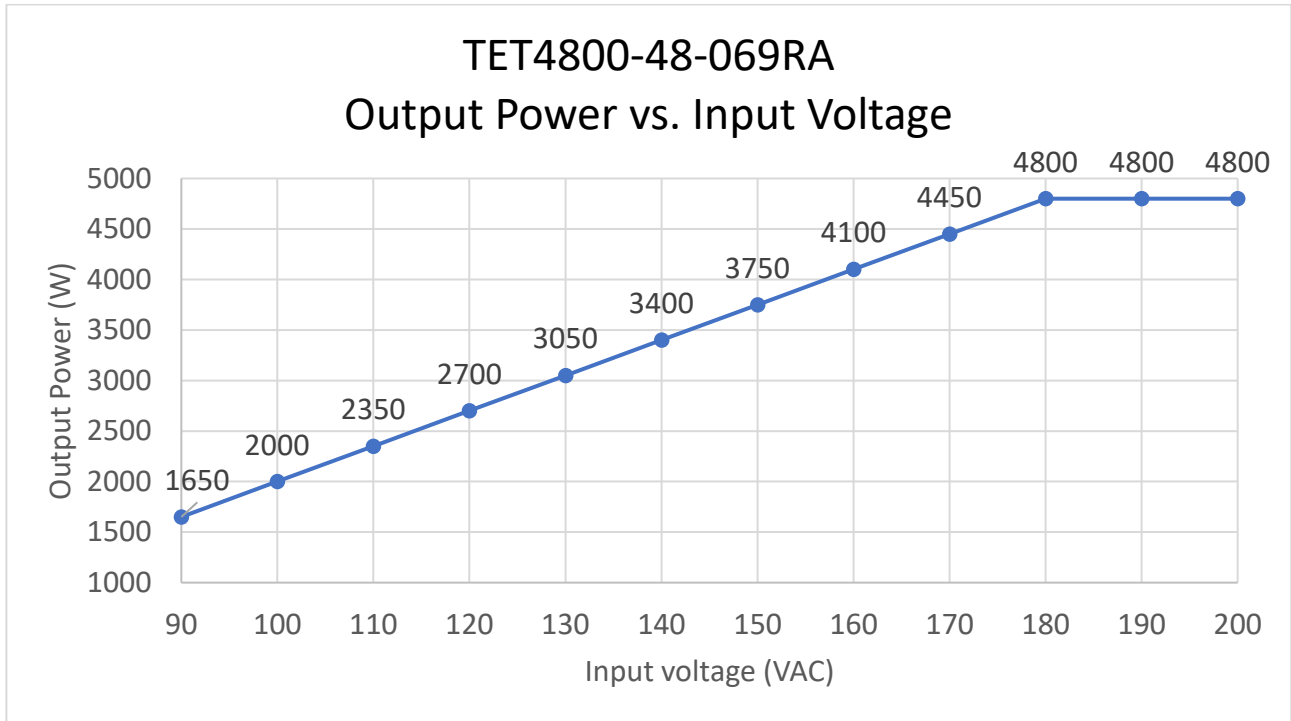

Figure 5. Output Power vs. Input Voltage



5.1. STANDBY OUTPUT

A standby output is available, delivering 12 V with up to 4 A, to provide power to system management controls.

The output is always enabled if the input voltage is within operating range, and provides over current, over voltage and over temperature protections. Current share on standby output is provided by passive droop sharing.

General Condition: $T_A = 0 \dots 45 \text{ }^\circ\text{C}$ unless otherwise noted.

PARAMETER	DESCRIPTION / CONDITION		MIN	NOM	MAX	UNIT
Standby output VSB						
$V_{SB \text{ nom}}$	Nominal Output Voltage	$I_{SB} = 0 \text{ A}, T_A = 25 \text{ }^\circ\text{C}$		12		VDC
$V_{SB \text{ set}}$	Output Setpoint Accuracy	$I_{SB} = 0 \text{ A}, T_A = 25 \text{ }^\circ\text{C}$	-2		+2	% $V_{SB \text{ nom}}$
$dV_{SB \text{ tot}}$	Total Regulation	$V_i \text{ min to } V_i \text{ max}, 0 \text{ to } 100 \% I_{SB \text{ nom}}, T_A \text{ min to } T_A \text{ max}$	-5		+3	% $V_{SB \text{ nom}}$
$P_{SB \text{ nom}}$	Nominal Output Power			48		W
$I_{SB \text{ nom}}$	Nominal Output Current			4		ADC
$V_{SB \text{ pp}}$	Output Ripple Voltage	20 MHz BW			300	mVpp
$dV_{SB \text{ Load}}$	Load Regulation	0 - 100 % $I_{SB \text{ nom}}$		-72		mV/A
$dV_{SB \text{ Line}}$	Line Regulation	$V_i = V_{i \text{ AC min}} \dots V_{i \text{ AC max}}$ OR $V_{i \text{ DC min}} \dots V_{i \text{ DC max}}$		0		mV
dI_{share}	Current Sharing	Deviation from $I_{SB \text{ tot}} / N$	-2		+2	ADC
dV_{dyn}	Dynamic Load Regulation	$\Delta I_{SB} = 50\% I_{SB \text{ nom}}, I_{SB} = 10 \dots 100\% I_{SB \text{ nom}},$ $dI_{SB}/dt = 0.1 \text{ A}/\mu\text{s}, f = 2 \dots 50 \text{ Hz},$ Duty cycle = 20 ... 80%	-600		+600	mV
T_{rec}	Recovery Time	Within 1% of V_{SB} final steady state			2	ms
$t_{\text{AC VSB}}$	Start-up Time from AC	Time from V_i in range to V_{SB} in regulation, $T_A > 10^\circ\text{C}$			3 ⁷	sec
$t_{V_{SB} \text{ rise}}$	Rise Time	$V_{SB} = 10 \dots 90\% V_{SB \text{ nom}}$		5		ms
$C_{V_{SB}}$	Maximum Capacitive Load				3000	μF

5.2. OUTPUT VOLTAGE RIPPLE

The internal output capacitance at the power supply output (behind OR-ing element) is minimized to prevent disturbances during hot plug. To provide low ripple voltage at the application, external capacitors should be added at the input of the connected load circuits.

5.3. OVERSUBSCRIPTION

The main output has the capability to allow a load current of up to 10 A above the nominal output current rating for a maximum duration of 5 ms. This allows the system to consume extended power for short time dynamic processes. Oversubscription can be used with maximum 10% duty cycle. If the output current is less than 10 A above nominal output current, then the oversubscription time can be longer.

5.4. OUTPUT ISOLATION

Main and standby output (if available) and all signals are isolated from the chassis and protective earth connection, although the applied voltage must not exceed 100 V_{peak} to prevent any damage to the power supply.

The main output return path serves as main and standby power return and reference for the two address signals ADDR0 and ADDR1. Care needs to be taken to reference these address signals as close as possible to the PSU's GND pins.

The CAN bus lines CAN_H and CAN_L, the output signal ACOK_L and the input signal PSKILL are referenced to signal ground SGND. These signals and SGND are isolated from main output and chassis allowing a maximum voltage of 50 V_{peak} between signals/SGND and main return GND. Signal ground SGND may be connected to power ground GND within the application, shown as dotted lines in *Figure 6*, allowing powering of system communication and logic from VSB output.

⁷ At low ambient temperature $T_A < 10 \text{ }^\circ\text{C}$ this time can rise to max 10s



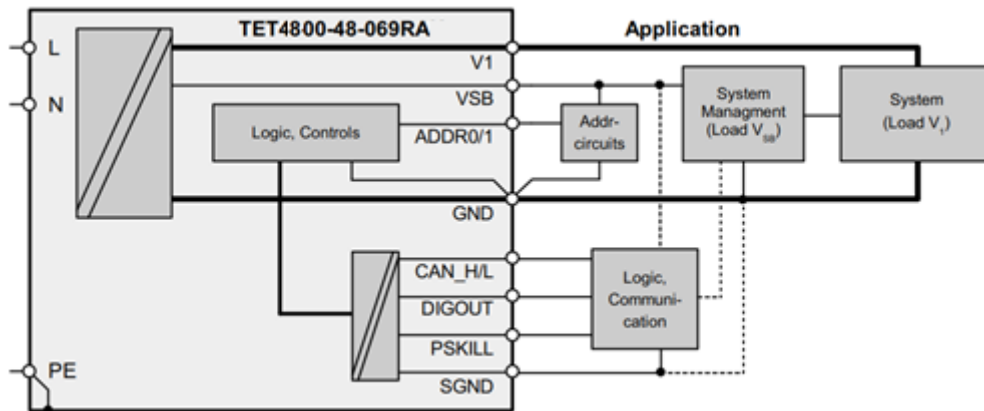

Figure 6. Output connection

6. PROTECTION

PARAMETER	DESCRIPTION / CONDITION	MIN	NOM	MAX	UNIT
F	Input Fuses (L)	Not user accessible, fast-acting (F)			A
$V_{1\text{ OV}}$	OV Threshold V_1	64	66	68	VDC
$t_{V1\text{ OV}}$	OV Latch Off Time V_1			1	ms
$P_{1\text{ lim}}$	Nominal Power Limitation	$V_{i\text{ AC HL}}, T_a \leq 45^\circ\text{C}, V_1 \geq 48\text{ V}$	4800	4909	W
		$V_{i\text{ AC HL}}, T_a = 55^\circ\text{C}, V_1 \geq 48\text{ V}$	4000	4349	W
$I_{1\text{ lim}}$	Nominal Current Limitation	$V_{i\text{ AC HL}}, T_a \leq 45^\circ\text{C}, V_1 = 54.5\text{ V}$	88	90	ADC
		$V_{i\text{ AC HL}}, T_a \leq 45^\circ\text{C}, V_1 = 42 \dots 48\text{ V}$	100	102	ADC
$I_{1\text{ lim}}$	Nominal Current Limitation	$V_{i\text{ AC HL}}, T_a = 55^\circ\text{C}, V_1 = 54.5\text{ V}$	73.4	77.8	ADC
$t_{1\text{ lim}}$	Power Limit Blanking Time	Time until power limit is reduced to nominal value			ms
$P_{1\text{ ol lim}}$	Power Limit during Short Time Over-Load V_1	$V_{i\text{ AC HL}}, T_a \leq 45^\circ\text{C}, V_1 \geq 48\text{ V}$, Maximum duration 10 ms			W
$I_{1\text{ ol lim}}$	Current Limit during Short Time Over-Load V_1	$V_{i\text{ AC HL}}, T_a \leq 45^\circ\text{C}, V_1 = 54.5\text{ V}$, Maximum duration 5 ms			A
$I_{1\text{ SC}}$	Max Short Circuit Current V_1	$V_1 < 10\text{ VDC}$, excluding output capacitor discharging current			ADC
$t_{1\text{ SC off}}$	Short Circuit Latch off time	Time to latch off when in short circuit or output under voltage ($V_1 < V_{1\text{ UV}}$)			ms
$V_{1\text{ UV}}$	Output Under Voltage Protection	39	40	41	VDC
$t_{1\text{ UV}}$	Output Under Voltage Protection Delay time	$V_1 < V_{1\text{ UV}}$			ms
T_{SD}	Over Temperature on critical points	Inlet Ambient Temperature	60		°C
		PFC Primary Heatsink Temperature	95		
		DC/DC Primary Heatsink Temperature	95		
		Secondary Sync MOSFET Temperature	115		
$V_{\text{SB OV}}$	Output Over Voltage Protection Standby	13.0	13.6	14.4	VDC
$V_{\text{SB UV}}$	Output Under Voltage Protection Standby	9.9	10.0	10.1	VDC
$I_{\text{SB Lim}}$	Standby Over Current Limit	4.7			ADC

6.1. LATCH OFF

Main Output: A fault on the main output will turn off only the main output. For all faults, the output is turned off and latch off, except:

- UVP – output will restart after 1sec. 3x restart is allowed, after that the output will latch off.
- OTP – once the temperature cools down, the output will restart.

Standby Output: A fault on the standby output will turn off only the standby output.

- OCP and UVP - output will restart after 1sec.
- OVP - output will restart after 1sec. 3x restart is allowed, after that the output will latch off.
- OTP – once the temperature cools down, the output will restart.

The latch off can be cleared by:

- Recycle PSKILL
- Recycle Input Voltage (at least 3sec off-time)
- Send CAN NMT Command

6.2. OVER VOLTAGE PROTECTION

For both Main and Standby outputs, the over voltage protection is implemented with a comparator. Once an OV condition is triggered, the output is turned off. Refer to Section 6.1 for latch off behavior.

6.3. UNDER VOLTAGE DETECTION

For both Main and Standby outputs, the under-voltage protection is implemented in firmware. Once a UV condition is triggered, the output is turned off. Refer to Section 6.1 for latch off behavior.

6.4. CURRENT LIMITATION MAIN OUTPUT

Two different over current protection features are implemented on the main output.

If the output current exceeds $I_{1\text{ lim}}$ for more than 10 ms the output will reduce its voltage, to reduce output current to $I_{1\text{ lim}}$. In case the output voltage will be reduced below the under-voltage level $V_{1\text{ UV}}$ the output will turn off after 100 ms, signaling an under-voltage fault.

The 2nd protection is a substantially rectangular output characteristic controlled by a software feedback loop. This protects the power supply and system during the 10 ms blanking time of the short time overload mode. If the output current is rising fast and reaches $I_{1\text{ ol lim}}$, the supply will immediately reduce its output voltage to prevent the output current from exceeding $I_{1\text{ ol lim}}$. When the output current is reduced below $I_{1\text{ ol lim}}$, the output voltage will return to its nominal value.

The main output current limitation level $I_{1\text{ lim}}$ and $I_{1\text{ ol lim}}$ are decreased if the ambient (inlet) temperature increases beyond 45°C. The current limit depends on programmed output voltage, to keep output power constant at about 4800 W.

See also

Figure for output characteristic and current limitation at different output voltage settings.



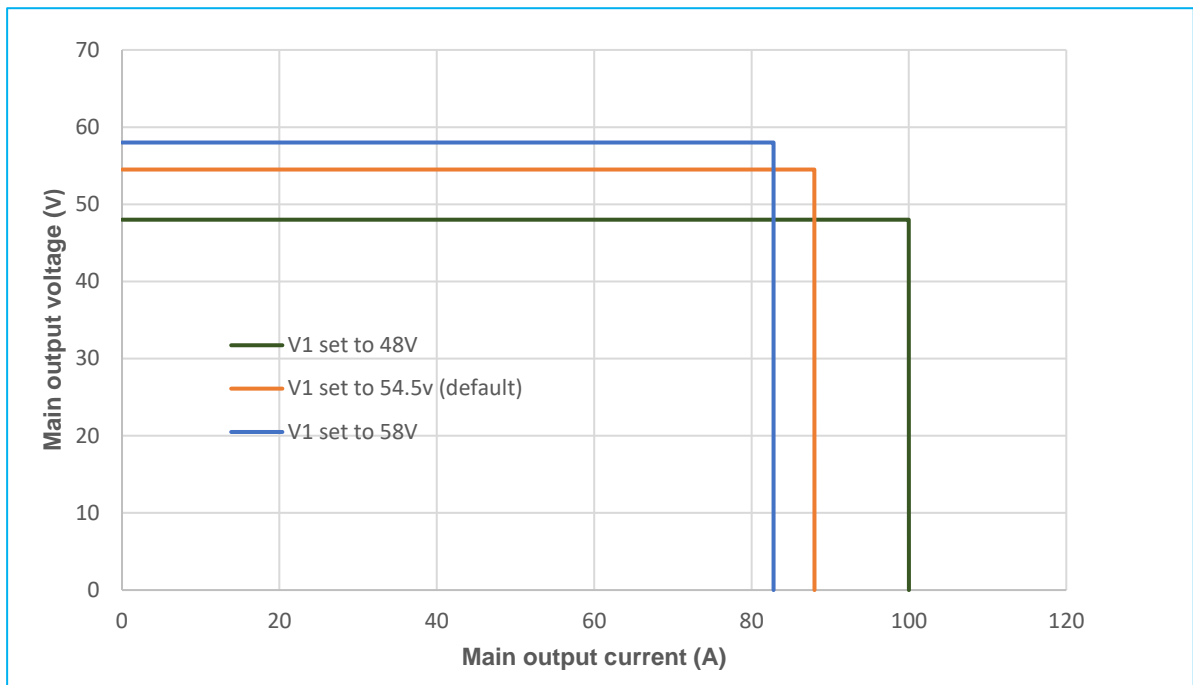

Figure 7. Output characteristics V_1

6.5. CURRENT LIMITATION STANDBY OUTPUT

The standby output has a hiccup current limitation implemented. If the standby current exceeds $I_{SB\ Lim}$ the standby converter switches off and retries automatically after 1 second off time.

7. MONITORING

The power supply provides information about operating conditions through its CAN bus interface. Details can be found in the CAN Communication Manual BCA.00231.0. Accuracy of sensors within PSU is given in following table.

PARAMETER	DESCRIPTION / CONDITION	MIN	NOM	MAX	UNIT	
$V_{i\ mon}$	Input RMS Voltage	$V_{i\ min} \leq V_i \leq V_{i\ max}$		-3	+3	V_{rms}
$I_{i\ mon}$	Input RMS Current	-1.25		+1.25	A_{rms}	
$P_{i\ mon}$	True Input Power	-250		+250	W	
$V_1\ mon$	V_1 Voltage	$V_1 > 40\ VDC$		-1	+1	%
$I_1\ mon$	V_1 Current	$I_1 > 25\ A$		-3	+3	%
		$I_1 \leq 25\ A$		-1	+1	A
$V_{SB\ mon}$	V_{SB} Voltage	$I_{SB} = 0 \dots 5A$		-0.25	+0.25	V
$I_{SB\ mon}$	V_{SB} Current	$I_{SB} = 0 \dots 5A$		-0.5	+0.5	A
$P_1\ mon$	P_1 Output Power	$P_1 > 1000\ W$		-3	+3	%
		$P_1 \leq 1000\ W$		-30	+30	W
$P_{SB\ mon}$	P_{SB} Output Power	$P_{SB} = 0 \dots 60W$		-4	+4	W
$T_{a\ mon}$	Inlet air temperature	$T_a = 0 \dots 45^\circ C$		-5	+5	$^\circ C$

8. SIGNALING AND CONTROL

8.1. ELECTRICAL CHARACTERISTICS

PARAMETER	DESCRIPTION / CONDITION	MIN	NOM	MAX	UNIT
PSKILL					
V_{IL}	Input low level voltage (Main output enabled)	-0.2		+0.8	V
V_{IH}	Input high level voltage (Main output disabled)	2.0		+3.5	V
$I_{L,H}$	Maximum input sink or source current	0		1	mA
$R_{puPSKILL}$	Internal pull up resistor on PSKILL to internal 3.3 V		4.7		k Ω
ACOK_L					
V_{OL}	Output low level voltage	$I_{sink} < 4 \text{ mA}$	-0.2	+0.4	V
V_{puACOK_L}	External pull up voltage	0		13	V
R_{puACOK_L}	Recommended external pull up resistor on ACOK_L at $V_{puACOK_L} = 3.3 \text{ V}$		10		k Ω
Low level output	Input voltage within operating range				
High level output	No input voltage, or low input voltage				

8.2. PSKILL INPUT

The PSKILL input is an active-high and trailing pin in the connector and is used to switch off the main output as soon as the power supply is being plugged out.

This input can be connected to SGND, enabling main output as soon as power supply is plugged-in into system with input voltage present. Alternatively, this input can be driven by a logical signal (preferably an open collector signal) from the application, allowing remote control of the main output.

The standby output will remain on regardless of the PSKILL input state.

This pin is isolated and referred to SGND. One 4.7 k Ω pullup resistor to 3.3 V is present within the power supply.

8.3. ACOK_L OUTPUT

The ACOK_L is an isolated open collector output referred to SGND. It requires an external pull-up resistor. A low voltage on this pin reflects input voltage to be within operating range.

8.4. CAN BUS INTERFACE

The CAN bus interface serves for information exchange between paralleled power supplies (e.g., for current share) and for communication with a system controller (e.g., voltage setting, monitoring). The CAN bus operates at 1000 kbit/s with a Bel defined protocol. System wiring requires only interconnection of CAN_H and CAN_L lines, in addition a 120 Ohm termination resistor is required at each end of the CAN bus to prevent signal reflections.

NOTE: To enable active current share between paralleled power supplies, their CAN bus interface must be interconnected.

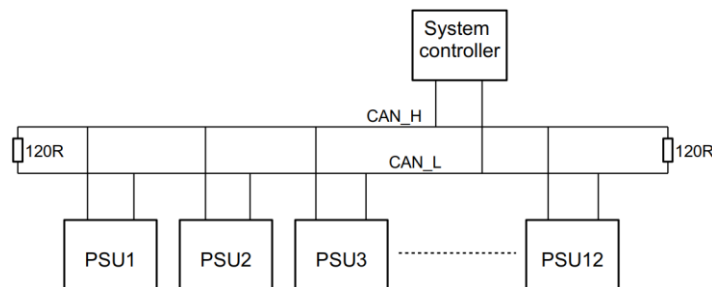

Figure 8. CAN bus wiring

8.5. CAN ADDRESSING

The CAN address (Node-ID) of each PSU is a combination of Shelf Number and PSU position within the shelf.

The Shelf-Number is given by a precision voltage source to be applied to the ADDR1 pin (versus power GND). The output impedance of this voltage source should not exceed 100 Ohm and the voltage range is between 0 V and 3.0 V. Accuracy is required to be ± 30 mV or better.

A resistor needs to be connected from the ADDR0 pin to power GND to define the position of the PSU slot within the shelf. The resistor tolerance needs to be $\pm 1\%$ or lower.

The resulting Node-ID is given by following formula: Node-ID = (Shelf-Nr - 1) * 16 + Slot-Nr.

If the PSU is not running, the ADDR0 pin is pulled low and the ADDR1 pin is switched to a high impedance input. Thus, the ADDR1 signal may be shared between PSUs while ADDR0 needs to be separated. Refer to the CAN manual for further information.

If either ADDR0 or ADDR1 pins are left open or shorted to GND or 3.0 V the PSU will detect an invalid Node-Id (reflected by corresponding LED state) and will not respond to a CAN request.

SHELF-NR	VOLTAGE ON ADDR1 [V]	SLOT-NR	RESISTOR ON ADDR0 [OHM]	RESULTING VOLTAGE ON ADDR0 [V]
1	0.332	1	150	0.130
2	0.664	2	470	0.374
3	0.998	3	866	0.624
4	1.330	4	1330	0.862
5	1.666	5	1960	1.118
6	1.998	6	2740	1.361
7	2.332	7	3900	1.625
8	2.664	8	5620	1.890
		9	8060	2.129
		10	12700	2.381
		11	22600	2.618
		12	75000	2.874

Table 1. Address pin voltage and resistor requirements

8.6. FRONT LEDs

The front-end has 2 front LEDs showing the status of the supply. LED number one is green and indicates AC power is on or off, while LED number two is bi-colored: green and yellow and indicates DC power presence or fault situations. If the PSU is bootloaded both LEDs are alternating green blinking. All other conditions are specified in the *Table 2*. The order of the criteria in the table corresponds to the testing precedence in the controller. LEDs are only available if sufficient input voltage is applied for operation of the internal supply circuits.

OPERATING CONDITION	LED SIGNALING
Boot loading	LEDs alternately blinking
AC LED	
AC Line within range	Solid Green
AC Line out of range	Off
DC LED	
V_I or V_{SB} out of regulation	
Over temperature shutdown	
Output over voltage shutdown (V_I or V_{SB})	Solid Yellow
Output under voltage shutdown (V_I or V_{SB})	
Output over current shutdown (V_I or V_{SB})	
Invalid Node-Id	Blinking Yellow
Main output disabled by application	Blinking Green
Normal Operation	Solid Green
PSU back supplied and input voltage present	Blinking Yellow
Otherwise	All LEDs off

Table 2. LED Status

8.7. CURRENT SHARE

The front-end has an active current share scheme implemented for V1. CAN bus interface of the paralleled power supplies need to be interconnected to activate the sharing function.

The controller implements a Master/Slave current share function. The power supply providing the largest current among the group is automatically the Master. The other supplies will operate as Slaves and increase their output current to a value close to the Master by slightly increasing their output voltage. The voltage increase is limited to +1 V.

The standby output uses a passive current share method (droop output voltage characteristic).

Due to non-ideal current share the maximum total output power of paralleled power supplies is less than the theoretical maximum and is defined in Table 3.

No of paralleled PSUs	Maximum available power on main output V		Maximum available power on standby output (optional)	
	without redundancy	n+1 redundancy	without redundancy	n+1 redundancy
1	4800 W	-	48 W	-
2	9360 W	4800 W	75 W	48 W
3	13910 W	9360 W	103 W	75 W
4	18470 W	13910 W	132 W	103 W
5	23040 W	18470 W	160 W	132 W
6	27590 W	23040 W	190 W	160 W

Table 3. Power available when PSU in redundant operation

9. TEMPERATURE AND FAN CONTROL

To achieve best cooling results sufficient airflow through the supply must be ensured. Do not block or obstruct the airflow at the rear of the supply by placing large objects directly at the output connector. The TET4800-48-069RA is provided with a reverse airflow, which means the air enters through the front of the supply and leaves at the rear.

9.1. FAN CONTROL

The average speed of the two individual fans within the dual-axis-fan is controlled to meet the reference. The reference is given by the maximum of following 3 items:

- Fan Speed vs Load Power curve, see Figure 9. This curve is in use at nominal conditions.
- Fan Speed vs Component Temperature curve. Refer to Figure 10.
- System command Fan Speed through CAN bus.

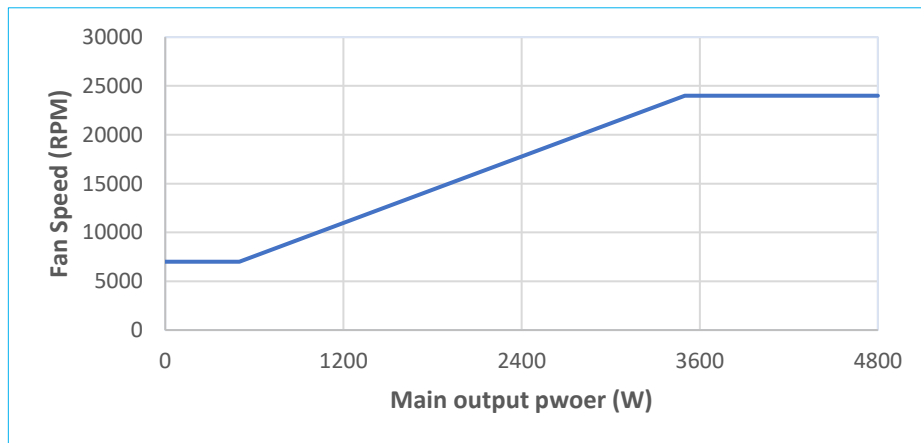

Figure 9. Fan speed versus main output power

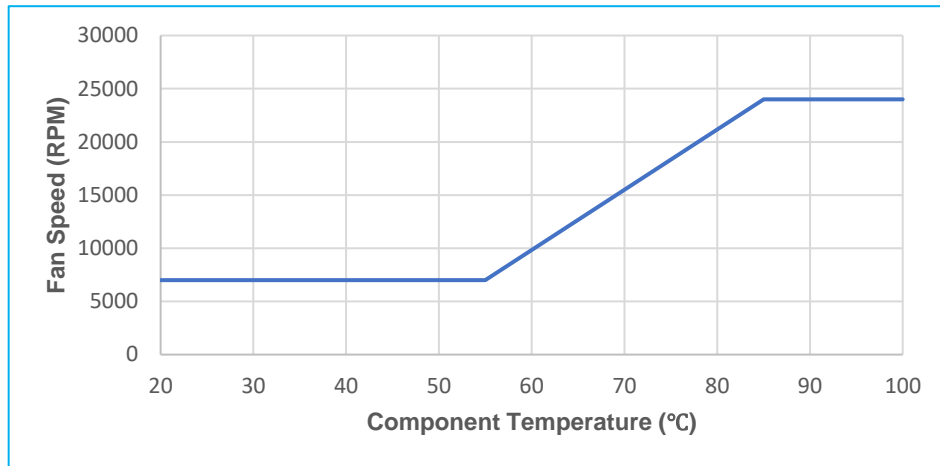

Figure 10. Fan speed versus power stage temperatures

10. ELECTROMAGNETIC COMPATIBILITY

10.1. IMMUNITY

NOTE: Most of the immunity requirements are derived from EN 55024:1998/A2:2003.

PARAMETER	DESCRIPTION / CONDITION	CRITERION
ESD Contact Discharge	IEC / EN 61000-4-2, ±8 kV, 25+25 discharges per test point (Metallic case, LEDs, connector body)	A
ESD Air Discharge	IEC / EN 61000-4-2, ±15 kV, 25+25 discharges per test point (Non-metallic user accessible surfaces)	A
Radiated Electromagnetic Field	IEC / EN 61000-4-3, 10 V/m, 1 kHz/80% Amplitude Modulation, 1 µs Pulse Modulation, 10 kHz...2 GHz	A
Burst	IEC / EN 61000-4-4, level 3 AC port ±2 kV, 1 minute	A
Surge	IEC / EN 61000-4-5, level 3 Line to earth: ±2 kV Line to line: ±2 kV	A
RF Conducted Immunity	IEC/EN 61000-4-6, Level 3, 10 Vrms,	A
Voltage Dips and Interruptions	IEC/EN 61000-4-11 1. V_i 230 Volts, 100% Load, Dip 100%, Duration 10 ms 2. V_i 230 Volts, 100% Load, Dip 100%, Duration ≤ 60 ms 3. V_i 230 Volts, 100% Load, Dip 100%, Duration > 60 ms	A V1: B, VSB: A B

10.2. EMISSION

PARAMETER	DESCRIPTION / CONDITION	CRITERION
Conducted Emission	EN 55032 / CISPR 32: 0.15 ... 30 MHz, QP and AVG	Class A
Radiated Emission	EN 55032 / CISPR 32: 30 MHz ... 1 GHz, QP	Class A
Harmonic Emissions	IEC 61000-3-12, $V_{in} = 230$ VAC, 50 Hz, 100% Load	Class A
Audible Noise LpA	V_{nom} , 50% $I_{o nom}$, $T_A = 25^\circ\text{C}$, at the bystander position	70 dBA
AC Flicker	IEC / EN 61000-3-11, $d_{max} < 3.3\%$	PASS

11. SAFETY / APPROVALS



Maximum electric strength testing is performed in the factory according to UL/CSA 62368-1, EN/IEC 62368-1. Input-to-output electric strength tests should not be repeated in the field. Bel Power Solutions will not honor any warranty claims resulting from electric strength field tests.

PARAMETER	DESCRIPTION / CONDITION	MIN	NOM	MAX	UNIT
Agency Approvals	Approved to the latest edition of the following standards: UL/CSA 62368-1, EN/IEC 62368-1				
Isolation Strength	Input (L/N) to case (PE) Input (L/N) to output Output to case (PE)		Basic Reinforced Functional		
α_c Creepage / Clearance	Primary (L/N) to protective earth (PE) Primary to secondary		According to UL/CSA 62368-1, EN/IEC 62368-1		
Electrical Strength Test	Input to case Input to output (tested by manufacturer only)	2500 5000			VDC

12. ENVIRONMENTAL

PARAMETER	DESCRIPTION / CONDITION	MIN	NOM	MAX	UNIT
T_A Ambient Temperature	$V_{I \min}$ to $V_{I \max}$, $I_{I \text{ nom}}$, $I_{SB \text{ nom}}$ at 4000 m $V_{I \min}$ to $V_{I \max}$, $I_{I \text{ nom}}$, $I_{SB \text{ nom}}$ at 1800 m	0 0		+35 +45	°C °C
$T_{A \text{ ext}}$ Extended Temp. Range	Derated output	+45		+55	°C
T_S Storage Temperature	Non-operational	-40		+70	°C
Altitude	Operational, above Sea Level (see derating)	-		4000	m
Cooling	System Back Pressure			0.5	in-H ₂ O

13. MECHANICAL

PARAMETER	DESCRIPTION / CONDITION	MIN	NOM	MAX	UNIT
Dimensions	Width		69		mm
	Height		40.6		mm
	Depth		528.4		mm
m Weight			2.7		kg

NOTE: A 3D step file of the power supply casing is available on request.

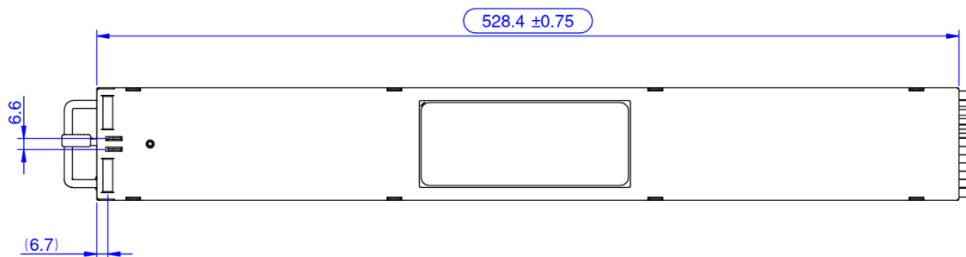
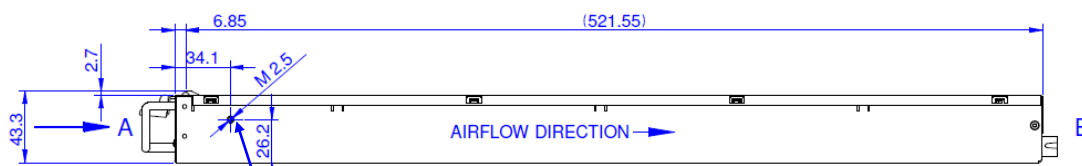

Figure 11. Top view



Keying screw that can be used to prevent wrong insertion of power supply, screw head $\phi 6.2$ mm max, height 1.6mm max

Figure 12. Side view



Asia-Pacific	Europe, Middle East	North America
+86 755 298 85888	+353 61 49 8941	+1 866 513 2839

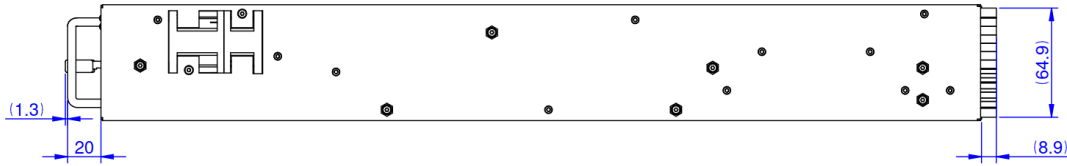

Figure 13. Bottom view

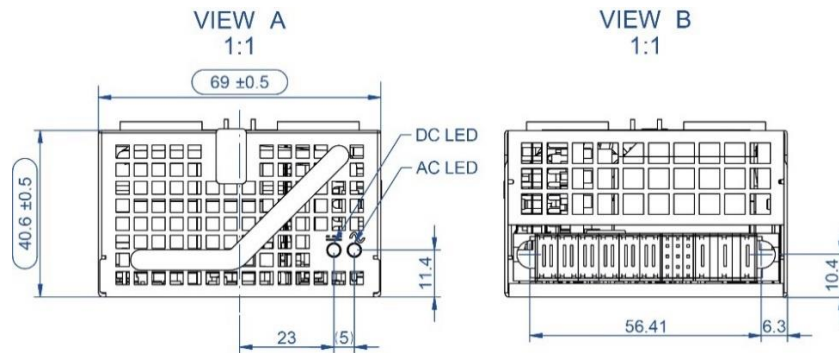

Figure 14. Front and Rear view

14. CONNECTOR

Rear side PSU connector serves as interface for input power, output power and signals. To guarantee proper mating sequence, the below noted connector P/N is required to be used.

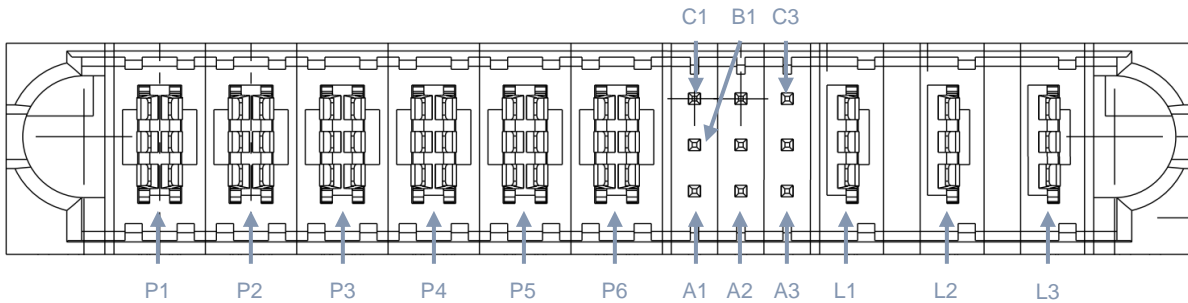



Figure 15. PSU rear side connector, view from mating side

VERSION	TYPE	MANUFACTURER	BEL P/N	MANUFACTURER P/N
PSU Connector	PWRBLADE ULTRA®	Amphenol FCI	-	10127397-07H1420LF or equivalent
System Connector	PWRBLADE ULTRA®	Amphenol FCI	ZES.01164	10127401-08H1420LF (Solder version)
			ZES.01224	10127400-01H1420LF (Press-Fit version)

PIN	SIGNAL NAME	DESCRIPTION	MATING SEQUENCE
L1	PE	Protective Earth	1
L2	N	AC or HV DC input line (Neutral)	2
L3	L	AC or HV DC input line (Line)	2
P1, P2, P3	GND	Power and ADDR0, ADDR1 return	1
P4, P5, P6	V1	+54.5 V main output	2
A1	PSKILL	Power supply kill input (lagging pin); active-high	3
B1	ACOK_L	Output signaling input voltage within operating range; active-low	2
C1	SGND	Isolated GND. CAN, PSKILL and ACOK_L are referred to it.	2
A2	ADDR0	Analog input for PSU address setting	2
B2	CAN_H	CAN-Interface, High ⁸	2
C2	CAN_L	CAN-Interface, Low ⁹	2
A3	ADDR1	Analog input for Shelf address setting ¹⁰	2
B3, C3	VSB	+12 V Standby output	2

Table 4. Pin assignment

15. ACCESSORIES

ITEM	DESCRIPTION	ORDERING PN	SOURCE
	Interface Utility Windows compatible GUI to program, control and monitor Bel products	N/A	belfuse.com/power-solutions
	Evaluation Board Evaluation board to operate 2PCS TET4800-48-069RA	YTM.U1900.0	Bel Power Solutions

⁸ With future I2C implementation will be optionally SDA

⁹ With future I2C implementation will be optionally SCL

¹⁰ With future I2C implementation will be optionally used as digital bidirectional share bus

16. REVISION HISTORY

REV	DESCRIPTION	DATE	AUTHOR
A	Initial Draft	2021-08-25	Rong Liang
B	<ol style="list-style-type: none"> 1. Output Power vs. Input voltage and Output Power vs. Temperature curve update. To make more margin for low line, so it is Ok for 120VAC grid fluctuation -10 % down to 108VAC in safety test. 2. Change V1 hold-up time T_{hold} from 13ms to 10ms 3. Change VSB rise time $t_{VSB\ rise\ min.}$ spec from 15ms to 10ms 4. Update Efficiency spec in Section 4 5. Update Figure 4. Output Power vs. Temperature. And update Figure 5. Output Power vs. Input Voltage 6. Update the fuses size to correct values in section 4.1 7. Change item 2 and 3 in "Voltage Dips and Interruptions" Duration $\leq 150ms$ to 60ms 8. Change some texts, tables, and figures format 9. Update to revision B 	2022-04-24	Gang Wang
C	<ol style="list-style-type: none"> 1. Add "or equivalent" to output connector at section 14 2. Update the safety approve standard and electrical strength test at section 11 	2023-08-24	Chad Cai

For more information on these products consult: tech.support@psbel.com

NUCLEAR AND MEDICAL APPLICATIONS - Products are not designed or intended for use as critical components in life support systems, equipment used in hazardous environments, or nuclear control systems.

TECHNICAL REVISIONS - The appearance of products, including safety agency certifications pictured on labels, may change depending on the date manufactured. Specifications are subject to change without notice.

